

# NaturalSof

Phone: (844) 966-7225

Web: [www.naturalsof.com](http://www.naturalsof.com)

Email: [info@naturalsof.com](mailto:info@naturalsof.com)



1855 Lockway Drive, Suite 506  
Alpharetta, GA 30004



Certified to NSF/ANSI 372

# NaturalSof

## Contents

Table of Contents .....	2
Start Up Instructions After Installation .....	3
Introduction .....	4
Water Quality & Conditions .....	4
Weather Considerations .....	4
Professional Installers & Local Laws .....	5
Automatic Control Valve Specifications .....	6
Master Programming .....	7
Internal System Materials and Certifications .....	8
(NSF/ANSI Standard 372) .....	8
(NSF/ANSI Standard 61) .....	8
Adsorption/Filtration (NSF/ANSI 42 & 53) .....	8
SRI Supreme Gravel Pack #6 .....	8
Garnet # 8 (2.0mm) .....	8
Clinoptilolite, Mesh Size 14x30 (0.55mm) .....	8
Coconut Shell-High Activated Carbon .....	8
High Activated Carbon (HAC) .....	8
KDF 55 Media .....	8
Catalytic Anti Scale Unit .....	9
Dimensions .....	9
Water and Power Connections .....	9
Performance Guideline Summary .....	10
Frequently Asked Questions .....	10
Troubleshooting .....	11





## Start Up Instructions After Installation

### We have intentionally placed these first for easy access and system start up.

Please make sure ALL connections are made and secure without over-tightening. Pay special attention to the back-washing line to the drain.

#### Start-up procedure

Once the valve is programmed and prior to turning the water on to the system, the following start-up procedure is recommended.

- 1: Push and hold the  button for 5 seconds, the valve will cycle to the backwash position. "Crack" the feed water valve to the system until you hear water flowing. This must be at a very slow flow rate. Unplug the power from the system and wait for the water to start flowing to the drain.
- 2: As soon as water starts flowing to the drain, plug the power back in and press and release the  button to cycle the valve to the rapid rinse position. Slowly open the feed water valve to the full open position. Unplug the valve and allow the system to rinse for no less than 30 minutes.
- 3: After 30 minutes of rapid rinsing, plug the power back in and press the  button to cycle the valve to the home position. Water should stop flowing to the drain. Press and hold the  button for 5 seconds and allow the system to go through a complete cleaning cycle. After the system returns to home, run several faucets to clear any remaining discoloration.
- 4: Discoloration of the treated water is common for several weeks. This will usually dissipate quickly.



Your new system must be installed correctly. The inlet and outlet are shown in the picture. The arrows have been enhanced in the picture for easier identification. Significant damage to the system and your plumbing can occur if the system is installed backwards.

If you suspect the system is installed incorrectly, simply close the bypass handle on the right (outlet) and put the system into a regeneration cycle. If the system was installed correctly, the unit will regenerate and the water to your house will be turned off. If it is installed backwards, the system will not regenerate and the house will also be turned off.



**INLET**

**OUTLET**





## Introduction

Thank you for purchasing your NaturalSof 6L hard water conditioner plus filtration system.

This system has been designed to provide you and your family with years of high-quality, low maintenance service. As water quality continues to become more of a daily issue, we are happy that you chose to improve the water you use in your home with our system.

The NaturalSof 6L will improve your water quality dramatically while removing or significantly reducing many common, objectionable contaminants that are found in municipally supplied water.

## Water Quality & Conditions

Water content and quality can vary greatly even within a few miles and from different treatment facilities within the same region or city. The NaturalSof 6L is designed to treat and filter common water conditions that are found in EPA regulated water utilities. Such as:

- ◇ Calcium Limescale caused by Hard Water
- ◇ Objectionable Taste & Odor
- ◇ Chlorine
- ◇ Chloramines
- ◇ Disinfectant Byproducts (DBPs)
- ◇ Trace Pharmaceuticals
- ◇ Low Level Bacteria

For more specific information about your local utility's water, review the Consumer Confidence Report (CCR) posted by or linked to from the Environmental Protection Agency Website:

[www.epa.gov/ccr](http://www.epa.gov/ccr)

You may also contact your water utility directly and ask for a hard copy if you do not have online access or if it is not posted online.

## Weather Considerations

If you live in an area that is subject to freezing temperatures, **DO NOT** install a NaturalSof 6L unit outside or in an area that may freeze seasonally. If installing inside of a garage in an area that has freezing temperatures, place the unit on an inside wall and/or make sure that the garage maintains a temperature above freezing at all times in extreme weather. Allowing a unit to freeze may cause components to crack and fail, resulting in water leaks. Outdoor covers must be installed to protect the electronics and valve from UV, rain and inclement weather conditions.

Units may be built to specification for outside installation if freezing is not a concern and you are installing outside. Be sure that your unit is built for outside installation by asking the dealer you purchased it from or contacting [sales@NaturalSof.com](mailto:sales@NaturalSof.com) directly.

Optional  
Environmental  
Cover



## Professional Installers & Local Laws

It is recommended that you contract a licensed plumber to install your NaturalSof 6L unit.

Check your local laws and ordinances to ensure compliance with any permitting, certifications, and material requirements prior to installing your unit.

Your plumber should be able to assist you with this. If you are planning on self-installing, call your local government offices or utility prior to installation and make sure to fully comply with all requirements.

## Internal System Materials and Certifications

While no federal regulations exist for residential water treatment devices, several voluntary national standards establish minimum requirements for the safety and performance of products used to treat home drinking water. These standards are generally divided according to the product's technology. The numbers assigned to each standard reflect the order in which the standards were developed.

### (NSF/ANSI Standard 372)

As of January 4, 2014, the Safe Drinking Water Act (SDWA) requires drinking water products sold or installed for use in public water systems, as well as plumbing in facilities, to meet a weighted average of not more than 0.25 percent lead. Third-party certification of these products to the new lead-free requirements will be required in many jurisdictions. Additionally, the states of California, Vermont, Maryland and Louisiana have already instituted these requirements for products currently in the market.

NSF certified products bearing these marks comply with the new lead-free requirements

### (NSF/ANSI Standard 61)

If you manufacture, sell or distribute water treatment or distribution products in North America, your products are required to comply with NSF/ANSI Standard 61: Drinking Water System Components – Health Effects by most governmental agencies that regulate drinking water supplies. Developed by a team of scientists, industry experts and key industry stakeholders, NSF/ANSI 61 sets health effects criteria for many water system components including:

- ◇ Protective barrier materials (cements, paints, coatings)
- ◇ Joining and sealing materials (gaskets, adhesives, lubricants)
- ◇ Mechanical devices (water meters, valves, filters)
- ◇ Pipes and related products (pipe, hose, fittings)
- ◇ Plumbing devices (faucets, drinking fountains)
- ◇ Process media (filter media, ion exchange resins)
- ◇ Non-metallic potable water materials

## Automatic Control Valve Specifications

- Commercial Grade automatic control valve
- Fast positioning reversible 10,000 RPM 12 volt DC drive motor
- Seal and spacer cartridge for easy servicing
- LCD – Backlit display that helps during low light conditions
- Precision cycle positioning using optical sensor
- No micro-switches or complex wiring
- Heavy duty drive train for the longest service life
- Programming will not be lost due to power outages
- Time of day backup for up to 12 hours of power loss
- Valve Material Fiber-reinforced polymer
- Simple programming, intuitive design
- High Flow 1.05" Riser
- Height from top of tank is 9" to 12"(additional height needed to remove cover)
- Highest flow rates, valve flows in excess of 25 GPM
- High Cv, (flow at 1 psi drop) 5.4 GPM

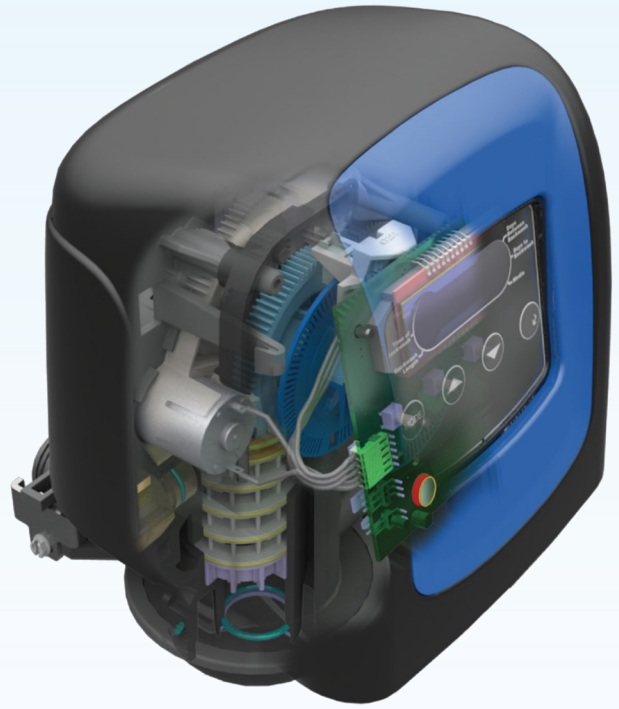

Unique bottom diffuser uses fine slots and a stacked cage/spine design for the highest flow rates and longest life!





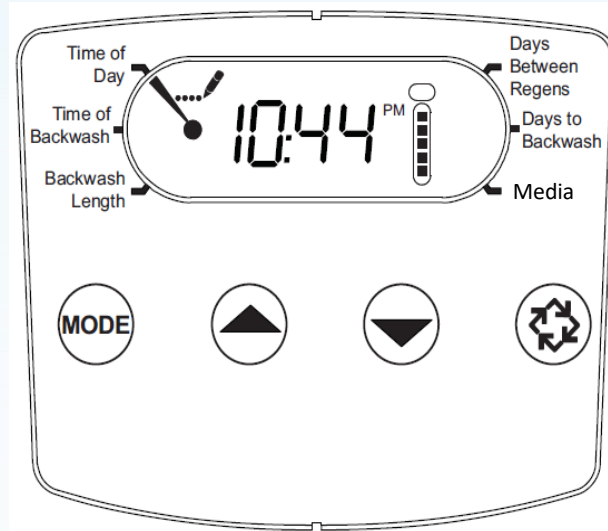







### Master Programming:

Upon initial power-up, the mode indicator (Black line) will likely be pointing to the “Time of Day” setting.

— — — — will be displayed. Press the up arrow button until the time setting replaces the — — — —. Do not set the time of day yet. Press the  button for 2 seconds and release. The  icon will disappear.

Press the  button to advance the black line to the “Media” setting. Use the up or down arrow buttons to set to “F”. Press the  button for 2 seconds and release. The  icon will disappear.

Press the  button to advance the black line and adjust all settings except for the “Media” using the up or down arrow buttons. Recommended settings are listed below.

**Time of Day:** Set to current time of day.

**Time of Backwash:** Set to 1:00 A.M.

**Backwash Length:** Set to 8 minutes

**Days Between Backwash:** Set to 21 days.

These are only guidelines.

Press the  button for 2 seconds to turn off the  icon. This will lock all changes into the valves memory.



## Adsorption/Filtration (NSF/ANSI 42 & 53)

This process occurs when liquid, gas or dissolved or suspended matter adheres to the surface of, or in the pores of, an adsorbent media. Carbon filters are an example of this type of product.

### **Materials Used in the NaturalSof 6L Multi-Media Backwashing System. Descriptions and certifications as follows:**

**SRI SUPREME GRAVEL PACK #6:** Provides base and protection for bottom distributor screen and enhances distribution of water through the media layers. NSF/ANSI 61

**GARNET # 8 (2.0MM):** When used in combination with the other filter medias, higher flow rates, higher loading, and better filtration is achieved. High hardness reduces attrition and provides for years of reliable service. An excellent support bed for other high density medias. Sediment filtration down to the 10-20 micron range. (the average human hair is about 100 microns in diameter) NSF/ANSI 61

**CLINOPTILOLITE, MESH SIZE 14X30 (0.55MM):** natural media with a large surface area and microporous structure, which can be used as a highly efficient filter media for the reduction of suspended matter. Viewed under an electron scanning microscope, the granules reveal an angular shape, rough surface and microporous void spaces as small as 3 microns. This creates a surface area over 100 times greater than silica sand. The angularity of the granules and the tapered internal pore spaces allow for reduction of dirt, silt and organic matter suspended in water by bridging, straining and adhesion. The rough surface and internal porosity provide a high surface area for efficient reduction of suspended matter. Utilizing deep bed filtration can typically reduce suspended solids down to the 5 micron or less range. (the average human hair is about 100 microns in diameter) NSF/ANSI 61

**COCONUT SHELL-HIGH ACTIVATED CARBON:** granular activated carbon is designed for reduction of tastes, odors and dissolved organic chemicals from municipal and industrial water supplies. Manufactured from select grades of coconut shell coal to produce a high density, durable granular product capable of withstanding the abrasion and dynamics associated with repeated hydraulic transport, backwashing and mechanical handling. Activation is carefully controlled to produce exceptionally high internal surface area with optimum pore size for the adsorption of a broad range of low molecular weight organic contaminants and oxidizing agents like chlorine and ozone. One of the most common applications for Coconut Shell-High Activated Carbon (CS-HAC) is the reduction of the undesirable tastes and odors present in many chlorinated water supplies. CS-HAC has been successful for many years in the reduction of free chlorine from water supplies. The end product is clean, fresh water with no objectionable taste or odor characteristics. NSF/ANSI 61

**HIGH ACTIVATED CARBON (HAC):** granular activated carbon is designed for reduction of tastes, odors and dissolved organic chemicals from municipal and industrial water supplies. Manufactured from select grades of bituminous coal to produce a high density, durable granular product capable of withstanding the abrasion and dynamics associated with repeated hydraulic transport, backwashing and mechanical handling. Activation is carefully controlled to produce exceptionally high internal surface area with optimum pore size for the adsorption of a broad range of high and low molecular weight organic contaminants. Primary use in the municipal application is the reduction of chloramine (chlorine and ammonia) and the disinfection byproducts caused by chlorination. These include chloroform and other trihalomethanes (THMs). NSF/ANSI 61

**KDF 55 MEDIA:** Designed specifically for removing or reducing chlorine and water-soluble heavy metals. Can remove up to 99% of water-soluble lead, mercury, nickel, chromium, and other dissolved metals. Is effective in controlling the buildup of bacteria, algae, and fungi, making it ideal for use in this mixed bed design filtration. NSF/ANSI Standard 42





**CATALYTIC ANTI SCALE UNIT:** As water passes through the internally mounted NaturalSof it is subjected to a turbulent interaction with a non-sacrificial, lead free, WQA NSF 61 & 372\* certified catalytic core made of a special alloy. This alloy core has a unique surface that causes a transformation to take place as water flows across it. The dissimilar metals and the water create a galvanic effect generating a very small electrical charge. This electric charge causes a percentage of the calcium and bicarbonate in the water to come out of solution and into suspension forming calcium carbonate in the aragonite state. The microscopic aragonite crystal formations remain suspended in the water and pass harmlessly through the system. As a result there is insufficient calcium remaining in solution to form scale in your pipework and appliances. Any Pre-Existing scale is simply washed away over time. NSF/ANSI 61, 372

## Dimensions

Overall Filter dimensions are approximately 12" x 60"

## Water and Power Connections

The standard water line in and out connections are 3/4", NPT, Plastic, (optional 1" connector available)

The pipe size for a residential drain line should be a minimum of 1/2" (13 mm).

The unit should be located close to a drain to prevent air breaks and back flow.

An uninterrupted alternating current (120 VAC) supply is required. The system includes a transformer to supply 12 VDC. Do not replace the transformer with a different power supply without consulting NaturalSo first. Do not cut or modify the transformer cable.

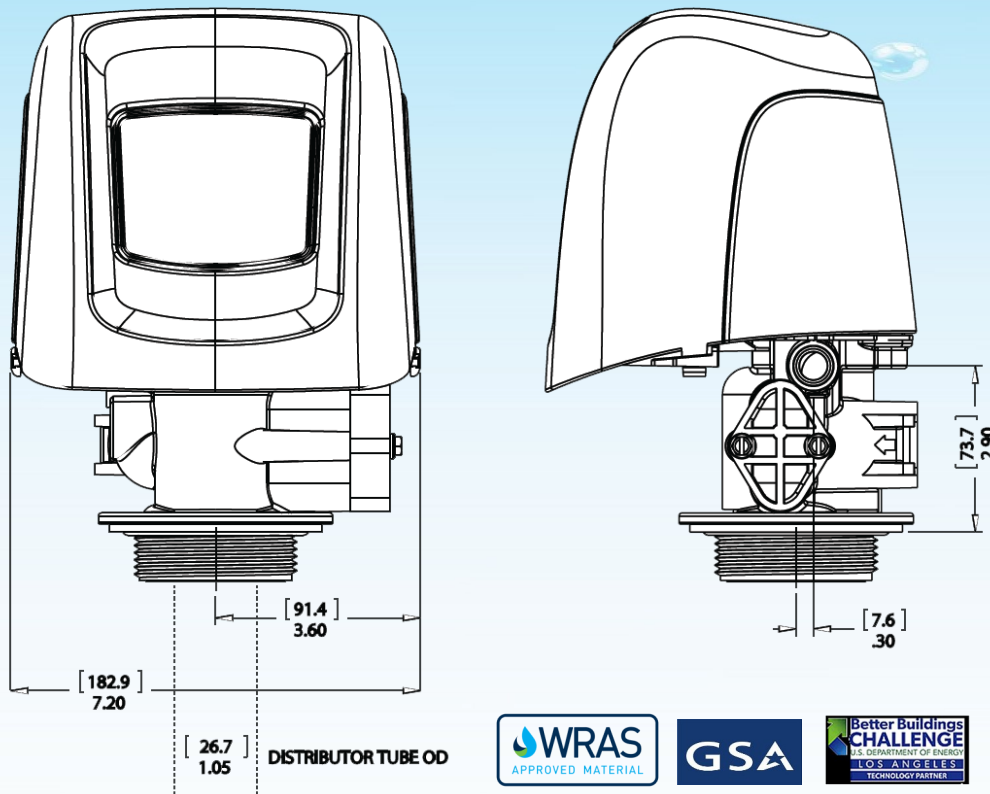



## Performance Guidelines Summary

Product performance may vary based on local water conditions, proper specification & application, proper plumbing application, setup, installation, startup, maintenance and/or usage.

Follow all applicable local plumbing codes.

The feed water must comply with the following conditions for all systems capabilities, compliances, and warranties to remain valid.

Water Temperature Range: minimum 40°F, maximum 80°F

Water Pressure: Point of Entry (POE): minimum 40 psi, maximum 75 psi

Water Flow Rates: water must be supplied to unit at a minimum of 1 GPM

Average Service Flow Rates: 1 to 4.5 GPM

Peak Flow Rates: With NS1 Inside = 10 GPM, With NS6 Inside = 16 GPM

Filtration Tank must be connected to main cold-water supply.

Secondary NaturalSof (NS05) must be installed in hot water recirculation loops for full and proper heater protection.

Do not allow the unit to freeze.

Do not use where water is microbiologically unsafe or with water of unknown quality without adequate disinfection before or after the system.

Do not allow backwash line to be stopped or restricted.

## Frequently Asked Questions

### How long will my system's filtration media last before it needs to be replaced?

Water quality and the volume of water run through the system will determine the total time of useful media life. With average usage and quality, you can expect 7 to 10 years of useful life before having to replace the layers of filtration within your unit.

### If I have a hot water re-circulation loop, must I install a secondary Naturalsof in it for proper protection?

Yes, you must install an NS05 on any hot water recirc pump to fully protect the hot water heater and appliances.

### Who do I contact with questions?

Please email your questions to: [sales@naturalsof.com](mailto:sales@naturalsof.com)

One of our representatives at NaturalSof will respond promptly. If you would like a representative to call you back personally, please be sure to include your phone # and state you reside in for local representation.

## Troubleshooting

Common Error Codes and solutions are found below. For a complete manual for your filter head, please email customer support at: [sales@naturalsof.com](mailto:sales@naturalsof.com)

Error Code	Error Type	Cause	Solution
Er-0	Motor stall, cam sensor error.	The electronic board did not sense movement by the optical sensor for 6 seconds.	Unplug the power. Remove the cover and inspect the wiring behind the electronic board. Make sure the optical encoder is in its proper position and the cord is connected. Push the motor into the valve to be sure it is seated correctly. Plug the power back in and watch that the piston moves.
Er-1	Optical Encoder has seen unexpected motion.	Non critical error. Information only.	Press any button to clear the error. This error can occur due to water hammer, or by simply hitting the valve. Be sure the water pressure does not exceed 75 PSI and install hammer arrestor if necessary.

Transformer port location (plugging in transformer)  
 When looking at valve from front, reach around back under cover on right hand side.  
 Transformer port is located just past the cover's snap feature.

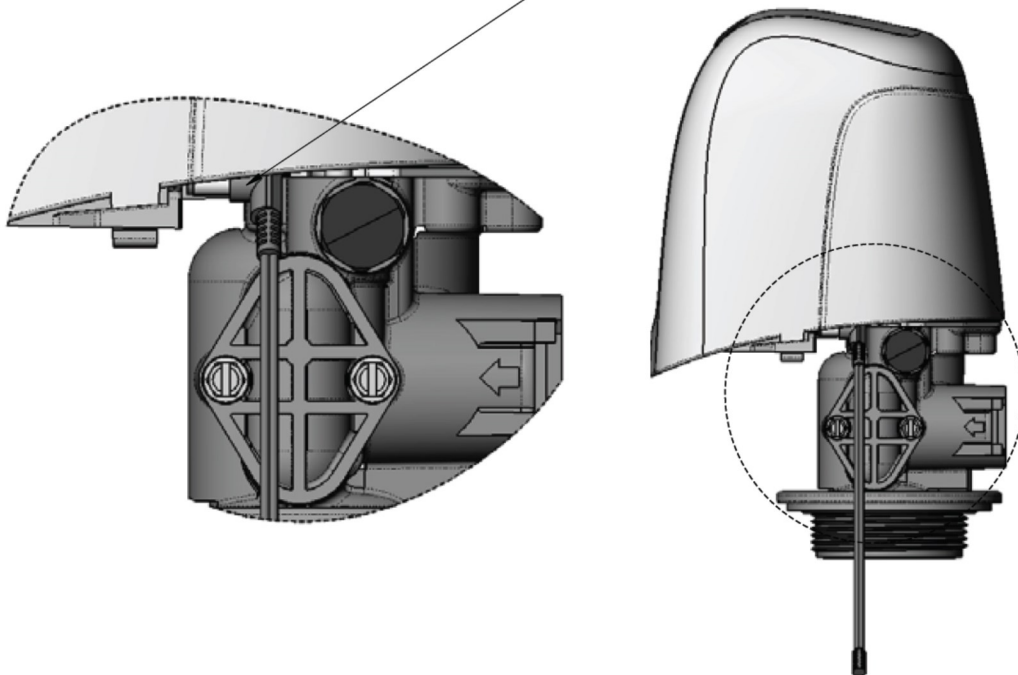

Hammer arrestors installed on the hot and cold water to your laundry can decrease common water hammer issues in residential applications







Phone: (844) 966-7225

Web: [www.naturalsof.com](http://www.naturalsof.com)

Email: [info@naturalsof.com](mailto:info@naturalsof.com)

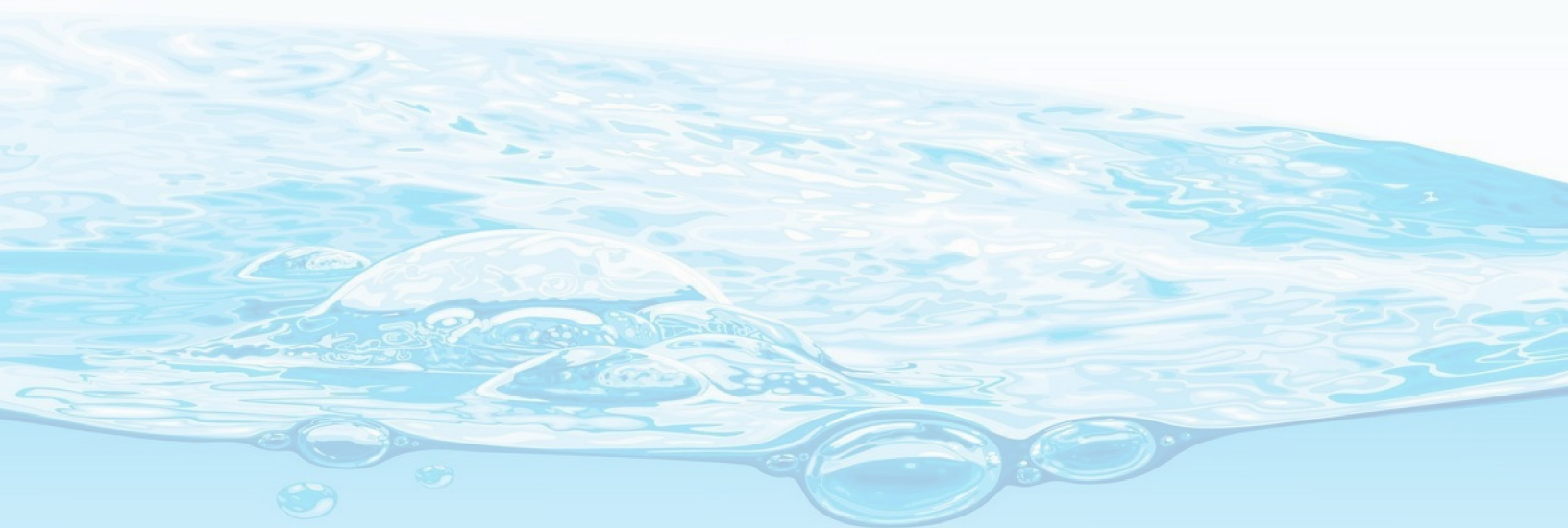

1855 Lockway Drive, Suite 506  
Alpharetta, GA 30004

